

**DATA SHEET**

# SKY65623-682LF: GPS/GLONASS/Galileo/Compass Low-Noise Amplifier

## Applications

- GPS/GLONASS/Galileo/Compass radio receivers
- Smartwatches
- Personal asset trackers
- Action cameras
- Personal navigation devices

## Features

- Small signal gain: 16.5 dB typical
- Low noise figure: 0.85 dB typical
- Out-of-band IIP3: -11.5 dBm typical
- Low current consumption: 1 mA typical
- Low shutdown current: 0.1  $\mu$ A typical
- Output impedance internally matched to 50  $\Omega$
- Single external input matching inductor
- Single DC supply: 1.5 to 3.6 V
- Minimal number of external components required
- Small QFN (5-pin, 0.8  $\times$  0.8 mm) package (MSL1, 260  $^{\circ}$ C per JEDEC J-STD-020)



Skyworks Green™ products are compliant with all applicable legislation and are halogen-free. For additional information, refer to *Skyworks Definition of Green™*, document number SQ04-0074.

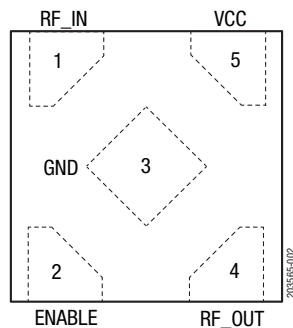

**Figure 2. SKY65623-682LF Pinout (Top View)**

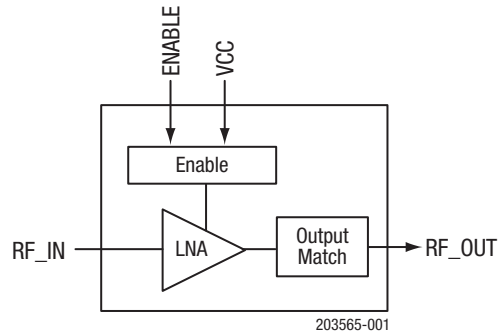

**Figure 1. SKY65623-682LF Block Diagram**

## Description

The SKY65623-682LF is a Microwave Monolithic Integrated Circuit (MMIC) front-end low-noise amplifier (LNA) designed for Global Navigation Satellite System (GNSS) radio receiver applications. The device provides low current consumption, excellent gain, and a superior noise figure (NF). Output matching components are embedded inside the device. Only one external input matching inductor is required.

The SKY65623-682LF is optimized to operate at 1559 to 1606 MHz, which makes it ideal for GPS/GLONASS/Galileo/Compass radio receiver applications.

The SKY65623-682LF is fabricated using advanced SiGe BiCMOS technology. The LNA uses surface-mount technology (SMT) in the form of a 0.8  $\times$  0.8 mm Quad Flat No-Lead (QFN) package, which allows for a highly manufacturable and low-cost solution.

A functional block diagram is shown in Figure 1. The pin configuration and package are shown in Figure 2. Signal pin assignments and functional pin descriptions are provided in Table 1.

**Table 1. SKY65623-682LF Signal Descriptions**

Pin	Name	Description	Pin	Name	Description
1	RF_IN	RF input	4	RF_OUT	RF output
2	ENABLE	LNA enable	5	VCC	Supply voltage
3	GND	Ground			

**Technical Description**

The ENABLE signal (pin 2) enables or disables the LNA DC power. A logic high signal powers on the LNA and a logic low signal powers off the device.

**Electrical and Mechanical Specifications**

The absolute maximum ratings of the SKY65623-682LF are provided in Table 2. The recommended operating conditions are specified in Table 3, and electrical specifications are provided in Tables 4 and 5.

**Table 2. SKY65623-682LF Absolute Maximum Ratings<sup>1</sup>**

Parameter	Symbol	Minimum	Maximum	Units
RF input power	Pin		0	dBm
Supply voltage	Vcc	0	4.5	V
Enable voltage	VEN	0	3.6	V
Storage temperature	TSTG	-55	+125	°C
Junction temperature	TJ		+125	°C
Electrostatic discharge:	ESD			
Charged Device Model (CDM), Class C1			250	V
Human Body Model (HBM), Class 2			2000	V

<sup>1</sup> Exposure to maximum rating conditions for extended periods may reduce device reliability. There is no damage to device with only one parameter set at the limit and all other parameters set at or below their nominal value. Exceeding any of the limits listed here may result in permanent damage to the device. Specifications are based on simulations.

**ESD HANDLING:** *Although this device is designed to be as robust as possible, electrostatic discharge (ESD) can damage this device. This device must be protected at all times from ESD when handling or transporting. Static charges may easily produce potentials of several kilovolts on the human body or equipment, which can discharge without detection. Industry-standard ESD handling precautions should be used at all times.*

**Table 3. SKY65623-682LF Recommended Operating Conditions<sup>1</sup>**

Parameter	Symbol	Min	Typ	Max	Units
Frequency range	f	1559	1575	1606	MHz
Supply voltage (measured at terminals of Evaluation Board)	Vcc	1.5	1.8	3.6	V
Enable voltage	VEN	1.5	1.8	Vcc	V
Case operating temperature	Tc	-40		+85	°C

<sup>1</sup> Specifications based on simulations.  
 Enable OFF voltage: 0.3 V (highest)  
 Enable ON voltage: Vcc-0.3 V (lowest)  
 Enable ON voltage should not exceed Vcc at any time.

**Table 4. SKY65623-682LF Electrical Specifications<sup>1</sup>**  
**(f = 1575 MHz, Vcc = 1.8 V, VEN = 1.8 V, Tc = +25 °C, Unless Otherwise Noted)**

Parameter	Symbol	Test Condition	Min	Typ	Max	Units
Small signal gain	IS21I	PIN = -40 dBm	15	16.5	18	dB
1 dB input compression point	IP1dB			-30		dBm
Noise figure	NF			0.85		dB
In-band third order input intercept point <sup>2</sup>	IIP3	f1 = 1575 MHz @ PIN = -40 dBm f2 = 1576 MHz @ PIN = -40 dBm		-21		dBm
Out-of-band third order input intercept point <sup>2</sup>	OOB-IIP3	f1 = 1713 MHz @ PIN = -20 dBm f2 = 1851 MHz @ PIN = -65 dBm IMD3 @ 1575 MHz = -90 dBm at output		-11.5		dBm
Reverse isolation	IS12I	PIN = -40 dBm		32		dB
Input return loss	IS11I	PIN = -40 dBm		10		dB
Output return loss	IS22I	PIN = -40 dBm		15		dB
Supply current	ICC	No RF		1	1.2	mA
Shutdown current	I <sub>LEAK</sub>	No RF, VEN = 0 V		0.1	1	μA
2 <sup>nd</sup> harmonic of 787 MHz <sup>2</sup>	HD2_787	PIN = -25 dBm, f1 = 787 MHz, measure output at 1574 MHz		-35		dBm
Turn ON/OFF time <sup>2</sup>		f = 1575 MHz, PIN = -30 dBm, Vcc = 1.8 V, 50% of VEN to 90%/10% of final RF power		1		μs

<sup>1</sup> Performance is guaranteed only under the conditions listed in this table. Specifications based on simulations.

<sup>2</sup> Verified by characterization.

**Table 5. SKY65623-682LF Electrical Specifications<sup>1</sup>**  
**(f = 1575 MHz, Vcc = 2.8 V, VEN = 2.8 V, Tc = +25 °C, Unless Otherwise Noted)**

Parameter	Symbol	Test Condition	Min	Typ	Max	Units
Small signal gain	IS21I	PIN = -40 dBm	15.3	16.8	18.3	dB
1 dB input compression point	IP1dB			-30		dBm
Noise figure	NF			0.85		dB
In-band third order input intercept point <sup>2</sup>	IIP3	f1 = 1575 MHz @ PIN = -40 dBm f2 = 1576 MHz @ PIN = -40 dBm		-21		dBm
Out-of-band third order input intercept point <sup>2</sup>	OOB-IIP3	f1 = 1713 MHz @ PIN = -20 dBm f2 = 1851 MHz @ PIN = -65 dBm IMD3 @ 1575 MHz = -93 dBm at output		-12.5		dBm
Reverse isolation	IS12I	PIN = -40 dBm		32		dB
Input return loss	IS11I	PIN = -40 dBm		10		dB
Output return loss	IS22I	PIN = -40 dBm		15		dB
Supply current	ICC	No RF		1.1	1.3	mA
Shutdown current	I <sub>LEAK</sub>	No RF, VEN = 0 V		0.1	1	μA
2 <sup>nd</sup> harmonic of 787 MHz <sup>2</sup>	HD2_787	PIN = -25 dBm, f1 = 787 MHz, measure output at 1574 MHz		-35		dBm
Turn ON/OFF time <sup>2</sup>		f = 1575 MHz, PIN = -30 dBm, Vcc = 2.8 V, 50% of VEN to 90%/10% of final RF power		1		μs

<sup>1</sup> Performance is guaranteed only under the conditions listed in this table. Specifications based on simulations.

<sup>2</sup> Verified by characterization.

### Evaluation Board Description

The SKY65623-682LF Evaluation Board is used to test the performance of the SKY65623-682LF LNA. An application schematic diagram is shown in Figure 3. Table 6 provides the Bill of Materials (BOM) list for Evaluation Board components. An assembly drawing for the Evaluation Board is shown in Figure 4. Evaluation Board layer details are shown in Figure 5, and the layer detail physical characteristics are shown in Figure 6.

### Package Dimensions

The PCB layout footprint for the SKY65623-682LF is provided in Figure 7. The typical part marking for the SKY65623-682LF is shown in Figure 8. Package dimensions for the 5-pin QFN are shown in Figure 9, and tape and reel dimensions are provided in Figure 10.

### Package and Handling Information

Instructions on the shipping container label regarding exposure to moisture after the container seal is broken must be followed. Otherwise, problems related to moisture absorption may occur when the part is subjected to high temperature during solder assembly.

The SKY65623-682LF is rated to Moisture Sensitivity Level 1 (MSL1) at 260 °C. It can be used for lead or lead-free soldering. For additional information, refer to the Skyworks Application Note, *Solder Reflow Information*, document number 200164.

Care must be taken when attaching this product, whether it is done manually or in a production solder reflow environment. Production quantities of this product are shipped in a standard tape and reel format.

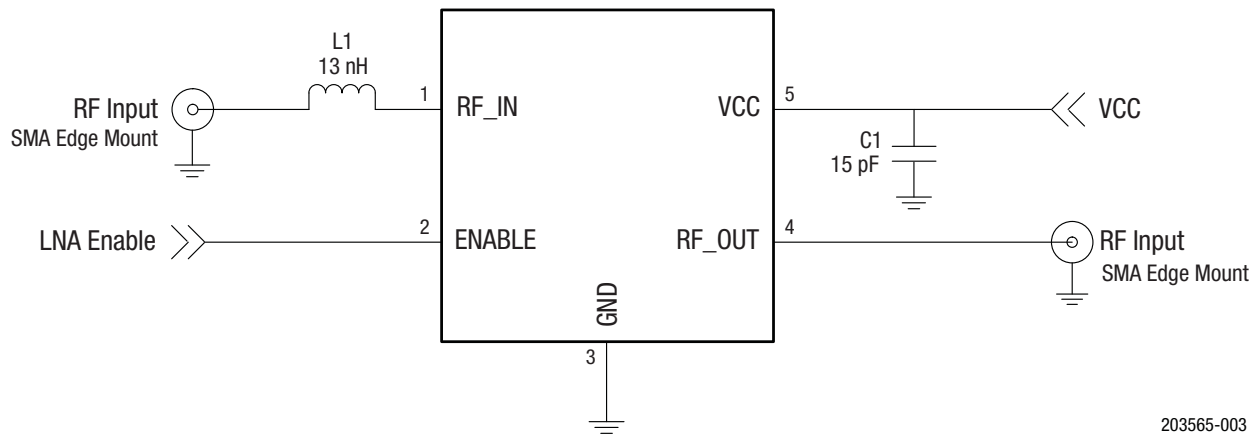

203565-003

Figure 3. SKY65623-682LF Application Schematic

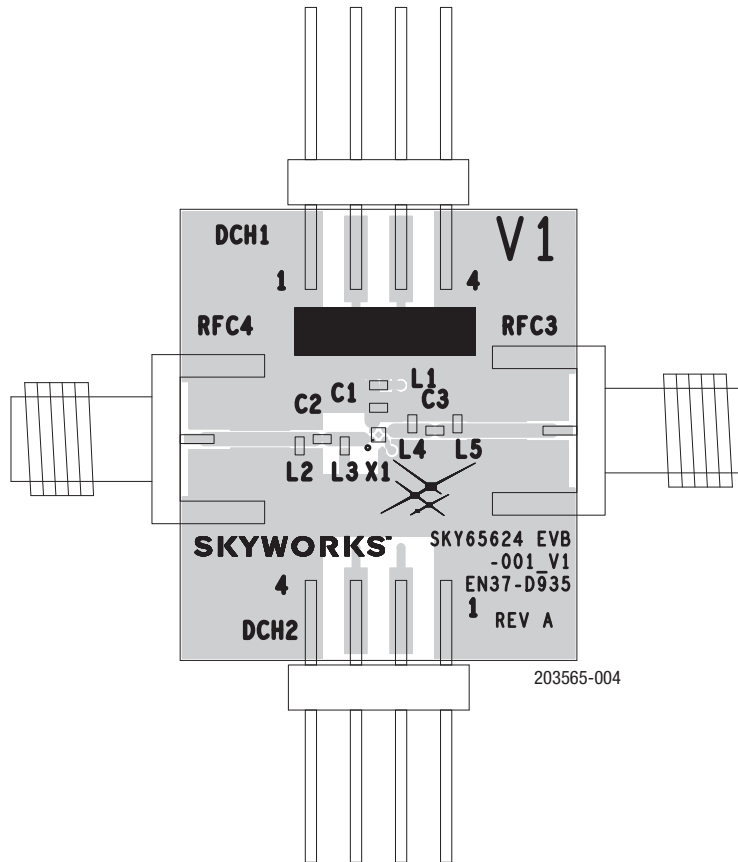

Figure 4. SKY65623-682LF Evaluation Board Assembly Diagram

Table 6. SKY65623-682LF Evaluation Board Bill of Materials

Component	Size	Value
C1 <sup>1</sup>	0402	15 pF
L1	0402	13 nH

<sup>1</sup> C1 needs to be placed as close as possible to the device in the application circuit.

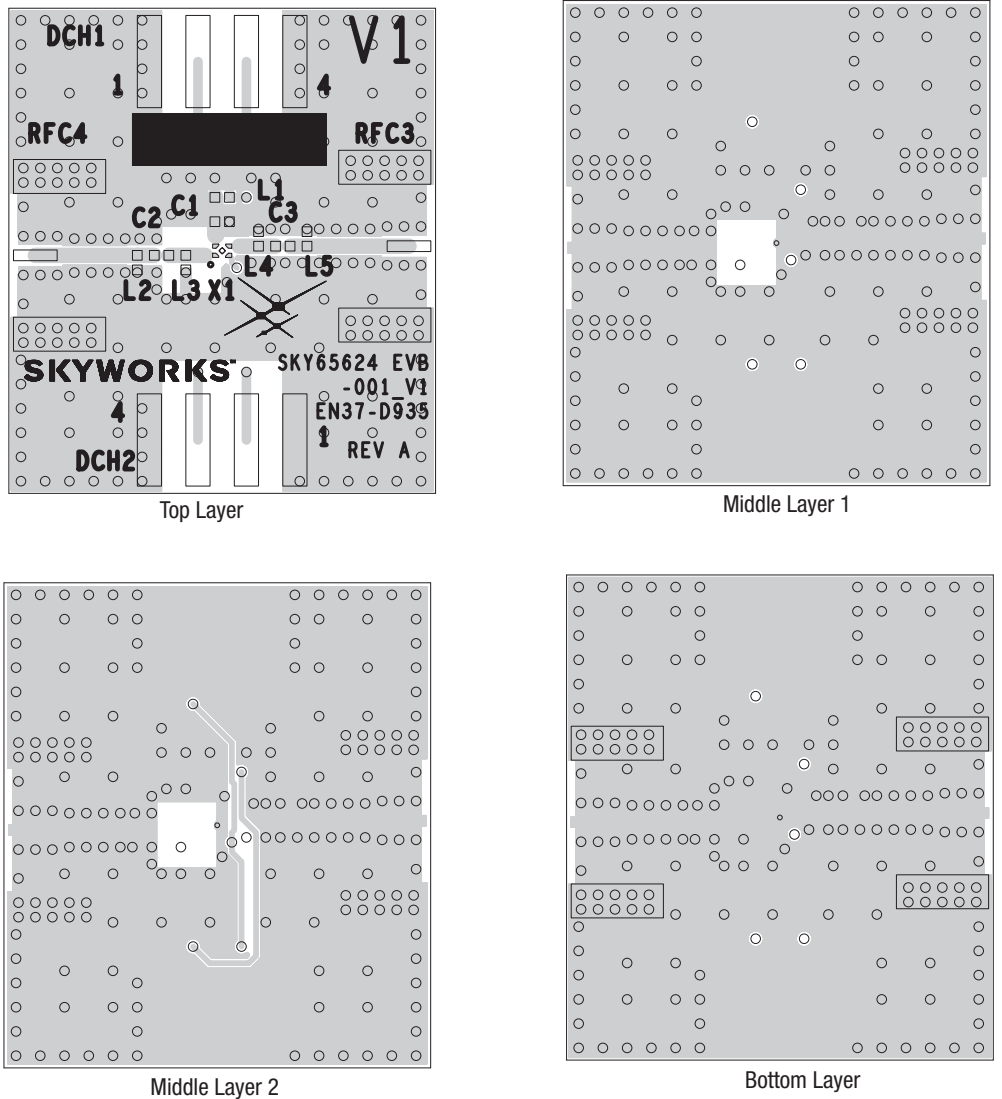
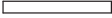

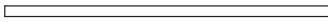

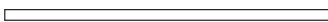
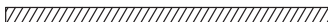
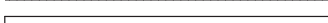

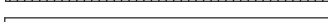

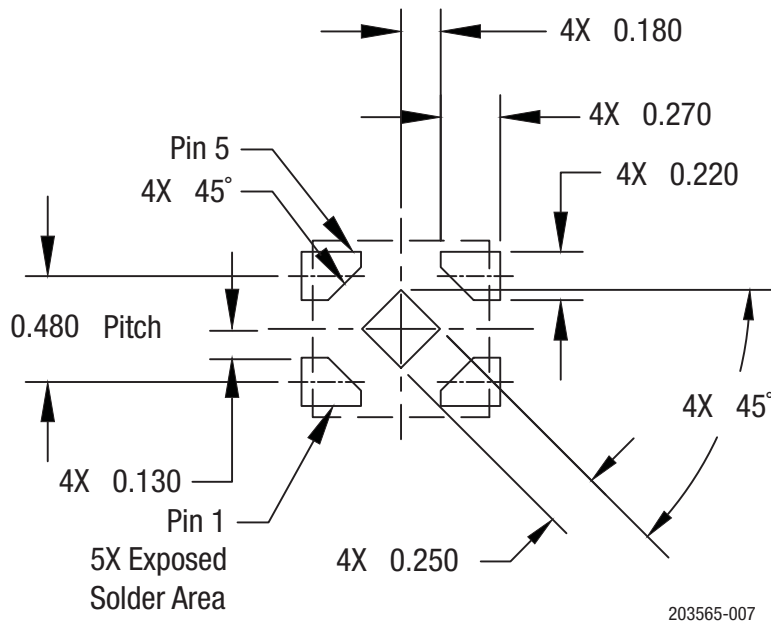

Figure 5. Evaluation Board Layer Details

50 Ω	CROSS SECTION	NAME	THICKNESS	MATERIALS
W = 0.500 mm 		TMASK	0.010 mm	SOLDER RESIST
		L1	0.025 mm	Cu – 1 oz
		DIELECTRIC	0.250 mm	R04350B
		L2	0.035 mm	Cu – 1 oz
		DIELECTRIC	1.000 mm	FR4
		L3	0.035 mm	Cu – 1 oz
		DIELECTRIC	0.250 mm	FR4
		L4	0.200 mm	Cu – 1 oz
		BMASK	0.010 mm	SOLDER RESIST

ts517

Figure 6. Layer Detail Physical Characteristics



**Figure 7. SKY65623-682LF PCB Layout Footprint**

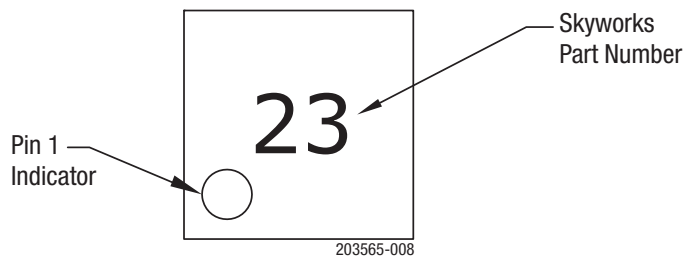

**Figure 8. SKY65623-682LF Typical Part Marking (Top View)**

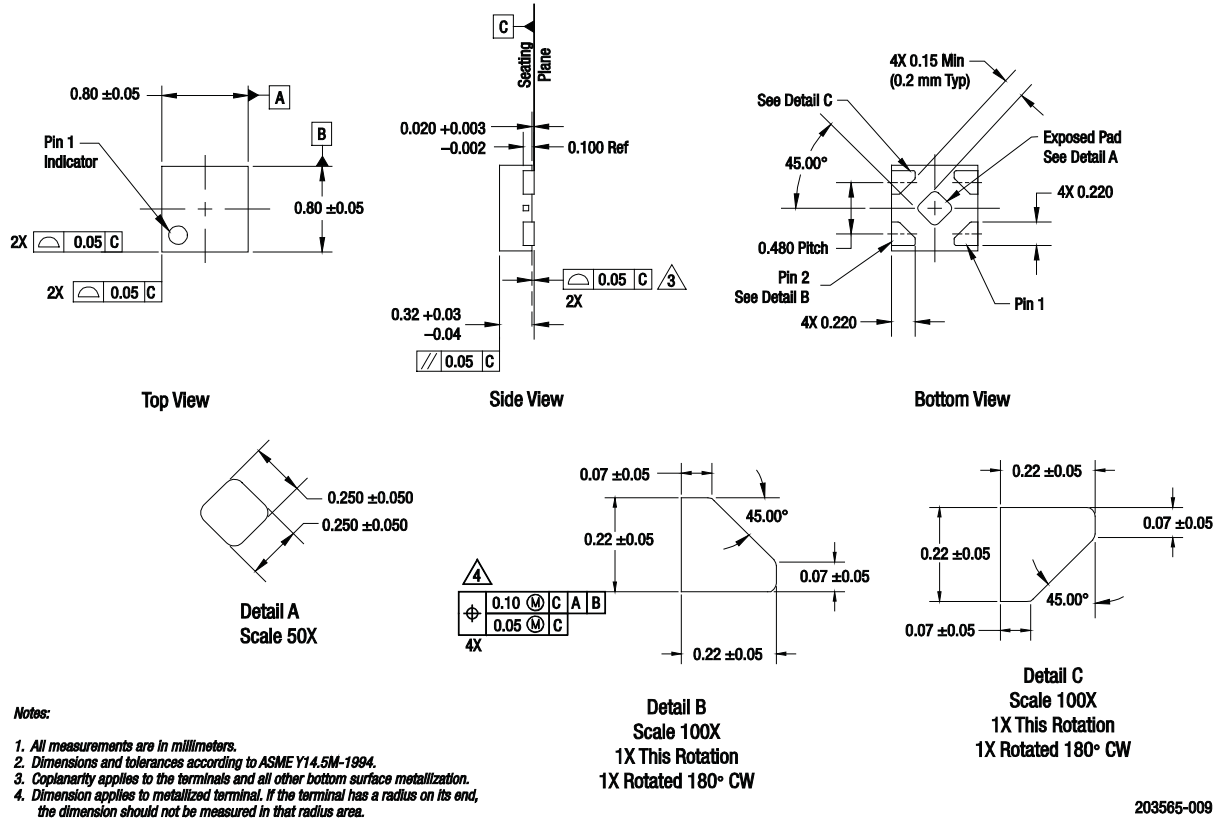

Figure 9. SKY65623-682LF Package Dimensions

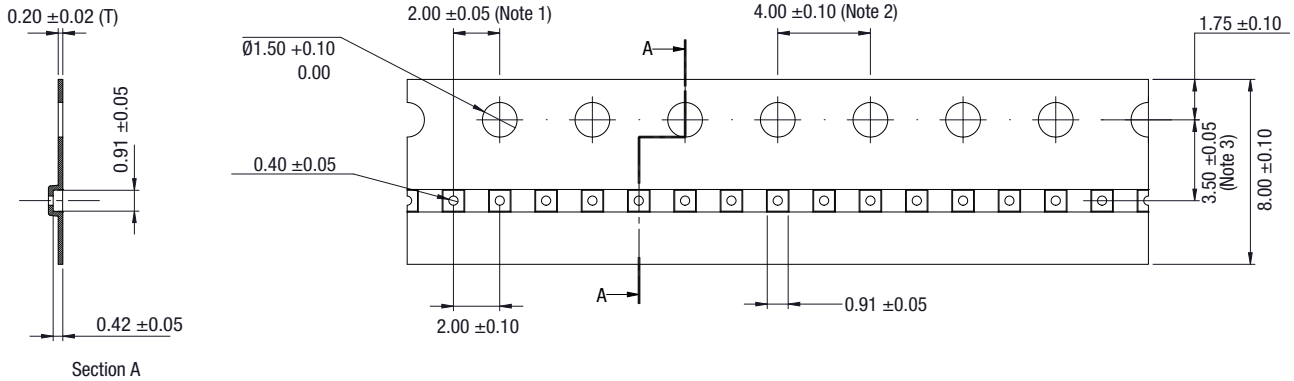

Figure 10. SKY65623-682LF Tape and Reel Dimensions



## Ordering Information

Model Name	Manufacturing Part Number	Evaluation Board Part Number
SKY65623-682LF: GPS/GLONASS/Galileo/Compass Low-Noise Amplifier	SKY65623-682LF	SKY65623-EVB

Copyright © 2015-2017 Skyworks Solutions, Inc. All Rights Reserved.

Information in this document is provided in connection with Skyworks Solutions, Inc. (“Skyworks”) products or services. These materials, including the information contained herein, are provided by Skyworks as a service to its customers and may be used for informational purposes only by the customer. Skyworks assumes no responsibility for errors or omissions in these materials or the information contained herein. Skyworks may change its documentation, products, services, specifications or product descriptions at any time, without notice. Skyworks makes no commitment to update the materials or information and shall have no responsibility whatsoever for conflicts, incompatibilities, or other difficulties arising from any future changes.

No license, whether express, implied, by estoppel or otherwise, is granted to any intellectual property rights by this document. Skyworks assumes no liability for any materials, products or information provided hereunder, including the sale, distribution, reproduction or use of Skyworks products, information or materials, except as may be provided in Skyworks Terms and Conditions of Sale.

THE MATERIALS, PRODUCTS AND INFORMATION ARE PROVIDED “AS IS” WITHOUT WARRANTY OF ANY KIND, WHETHER EXPRESS, IMPLIED, STATUTORY, OR OTHERWISE, INCLUDING FITNESS FOR A PARTICULAR PURPOSE OR USE, MERCHANTABILITY, PERFORMANCE, QUALITY OR NON-INFRINGEMENT OF ANY INTELLECTUAL PROPERTY RIGHT; ALL SUCH WARRANTIES ARE HEREBY EXPRESSLY DISCLAIMED. SKYWORKS DOES NOT WARRANT THE ACCURACY OR COMPLETENESS OF THE INFORMATION, TEXT, GRAPHICS OR OTHER ITEMS CONTAINED WITHIN THESE MATERIALS. SKYWORKS SHALL NOT BE LIABLE FOR ANY DAMAGES, INCLUDING BUT NOT LIMITED TO ANY SPECIAL, INDIRECT, INCIDENTAL, STATUTORY, OR CONSEQUENTIAL DAMAGES, INCLUDING WITHOUT LIMITATION, LOST REVENUES OR LOST PROFITS THAT MAY RESULT FROM THE USE OF THE MATERIALS OR INFORMATION, WHETHER OR NOT THE RECIPIENT OF MATERIALS HAS BEEN ADVISED OF THE POSSIBILITY OF SUCH DAMAGE.

Skyworks products are not intended for use in medical, lifesaving or life-sustaining applications, or other equipment in which the failure of the Skyworks products could lead to personal injury, death, physical or environmental damage. Skyworks customers using or selling Skyworks products for use in such applications do so at their own risk and agree to fully indemnify Skyworks for any damages resulting from such improper use or sale.

Customers are responsible for their products and applications using Skyworks products, which may deviate from published specifications as a result of design defects, errors, or operation of products outside of published parameters or design specifications. Customers should include design and operating safeguards to minimize these and other risks. Skyworks assumes no liability for applications assistance, customer product design, or damage to any equipment resulting from the use of Skyworks products outside of stated published specifications or parameters.

Skyworks and the Skyworks symbol are trademarks or registered trademarks of Skyworks Solutions, Inc., in the United States and other countries. Third-party brands and names are for identification purposes only, and are the property of their respective owners. Additional information, including relevant terms and conditions, posted at [www.skyworksinc.com](http://www.skyworksinc.com), are incorporated by reference.